

nses

K51300.02.TR.WH-BK.15.ST.9.27.PU

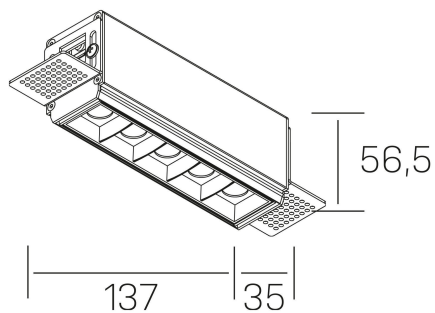

GENERAL DETAILS

| | |
|--------------------|-------------|
| INSTALLATION | Trimless |
| FINISHES ALUMINIUM | Black-White |
| LIGHT DIRECTION | Fixed |
| BEAM ANGLE | 15° |
| INT/EXT IP DEGREE | IP20 |
| MATERIAL | Aluminum |
| IK DEGREE | IK 6 |
| UTILIZATION | Indoor |
| WARRANTY | 3 years |

ELECTRICAL DETAILS

| | |
|------------------------|-----------|
| LAMP | LED |
| POWER | 10W |
| COLOUR TEMPERATURE | 3000K |
| LUMINOUS FLUX | 875 Lm |
| EFFICACY DIMMING | 73 Lm/W |
| DIMABLE | Push |
| DRIVER | Remote |
| CLASS PROTECTION | II |
| COLOUR RENDERING INDEX | CRI>90 |
| VOLTAGE | 220-240 V |
| FRECUENCIA | 50-60 Hz |
| CURRENT INTENSITY | 700 mA |
| LIFE TIME | 50.000 h |

GENERAL DIMENSIONS

| | |
|-------------------------|------------------|
| DIMENSIONS | 137×35 mm |
| CUT OUT | 143×70 mm |
| HEIGHT | h 56.5 mm |
| DIMENSIONES DE EMBALAJE | 190 × 80 × 85 mm |
| PESO NETO | 48 |

*Please might expect a max.15% figure reduction in finishes other than white