

nseS
K51300.01.RF.WH-BK.45.ST.9.27.PU

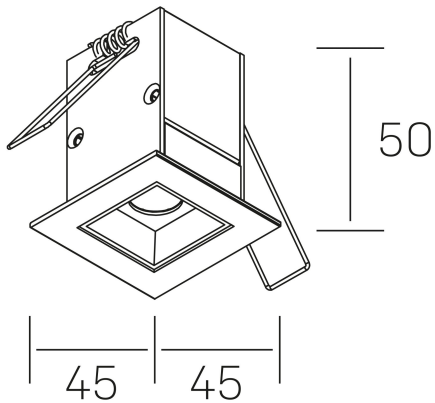

GENERAL DETAILS

INSTALLATION	recessed with frame
FINISHES ALUMINIUM	Black-White
LIGHT DIRECTION	Fixed
BEAM ANGLE	45°
INT/EXT IP DEGREE	IP20/23
MATERIAL	Aluminum
IK DEGREE	IK 6
UTILIZATION	Indoor
WARRANTY	3 years

ELECTRICAL DETAILS

LAMP	LED
POWER	2 W
COLOUR TEMPERATURE	2700K
LUMINOUS FLUX	175 Lm
EFFICACY DIMMING	58 Lm/W
DIMABLE	Push
DRIVER	Remote
CLASS PROTECTION	II
COLOUR RENDERING INDEX	CRI>90
VOLTAGE	220-240 V
FRECUENCIA	50-60 Hz
CURRENT INTENSITY	700 mA
LIFE TIME	35.000 h

GENERAL DIMENSIONS

DIMENSIONS	45×45 mm
CUT OUT	37×37 mm
DIMENSIONES DE EMBALAJE	115 × 85 × 80 mm
PESO NETO	14

*Please might expect a max.15% figure reduction in finishes other than white