

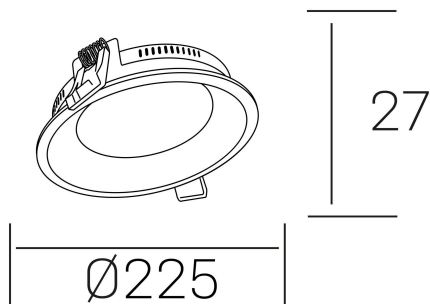

lim miranda
K53100.03.RF.WH-WH.OP.ST.8.40.PC



GENERAL DETAILS

INSTALLATION	recessed with frame
FINISHES ALUMINIUM	White-White
OPTIC COVER	Opal
LIGHT DIRECTION	Fixed
INT/EXT IP DEGREE	IP 44
MATERIAL	Aluminum
IK DEGREE	IK03
UTILIZATION	Indoor
WARRANTY	3 years

ELECTRICAL DETAILS

LAMP	LED
POWER	22 W
COLOUR TEMPERATURE	4000K
LUMINOUS FLUX	1900 lm
EFFICACY DIMMING	81 Lm/W
DIMABLE	PHASE CUT
DRIVER	Remote
CLASS PROTECTION	II
COLOUR RENDERING INDEX	CRI >80
VOLTAGE	220-240 V
FRECUENCIA	50-60 Hz
CURRENT INTENSITY	600 mA
LIFE TIME	50.000 h

GENERAL DIMENSIONS

DIMENSIONS	Ø 225 mm
CUT OUT	Ø 215 mm
HEIGHT	h 27 mm
DIMENSIONES DE EMBALAJE	270 × 270 × 45 mm
PESO NETO	0.60

*Please might expect a max.15% figure reduction in finishes other than white