



GENERAL DETAILS

| | |
|-----------------------|---------------------|
| INSTALACIÓN | recessed with frame |
| COLOR EXT-INT | White-White |
| DIRECCIÓN DE LA LUZ | Fixed |
| ÁNGULO DEL HAZ DE LUZ | 36° |
| INT-EXT ESTANQUEIDAD | IP20/33 |
| MATERIAL | Aluminum |
| RESISTENCIA MECÁNICA | IK05 |
| USO | Indoor |
| GARANTÍA | 5 years |

ELECTRICAL DETAILS

| | |
|----------------------------------|-----------|
| FUENTE DE LUZ | LED |
| POTENCIA | 9 W |
| TEMPERATURA DE COLOR | 2700K |
| FLUJO LUMÍNICO | 565 Lm |
| EFICIENCIA LUMÍNICA | 50 Lm/W |
| DIMABLE | DALI |
| DRIVER | Remote |
| CLASE DE SEGURIDAD | II |
| ÍNDICE DE REPRODUCCIÓN CROMÁTICA | CRI>90 |
| TENSIÓN | 220-240 V |
| CORRIENTE | 200 mA |
| VIDA UTIL | 50.000 h |

GENERAL DIMENSIONS

| | |
|-------------------------|------------------|
| DIMENSIÓN | Ø 56mm |
| AGUJERO DE CORTE | Ø 48 mm |
| ALTURA | h 72 mm |
| DIMENSIONES DE EMBALAJE | 83 × 80 × 115 mm |
| PESO NETO | 0.196 |

*Please might expect a max.15% figure reduction in finishes other than white

versus muzzy
K51101.01.RF.WH-WH.36.ST.9.27.DA

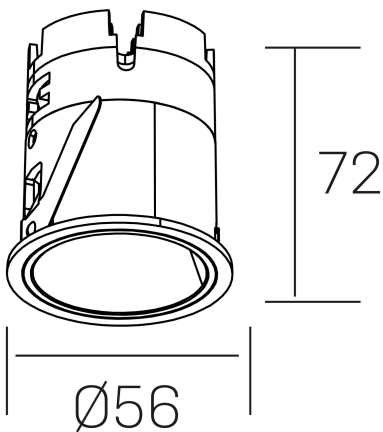

Ø56

72