

**nses**  
K51300.02.SR.WH-BK.15.ST.9.30

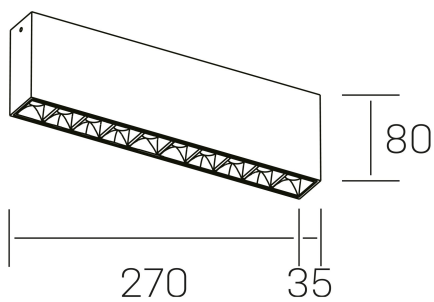

#### GENERAL DETAILS

INSTALACIÓN	Surface
COLOR EXT-INT	Black-White
DIRECCIÓN DE LA LUZ	Fixed
ÁNGULO DEL HAZ DE LUZ	15º
INT-EXT ESTANQUEIDAD	IP20
MATERIAL	Aluminum
RESISTENCIA MECÁNICA	IK 6
USO	Indoor
GARANTÍA	5 years

#### ELECTRICAL DETAILS

FUENTE DE LUZ	LED
POTENCIA	20 W
TEMPERATURA DE COLOR	3000K
FLUJO LUMÍNICO	1530 Lm
EFICIENCIA LUMÍNICA	73 Lm/W
DIMABLE	No Dim
DRIVER	Integrated
CLASE DE SEGURIDAD	II
ÍNDICE DE REPRODUCCIÓN CROMÁTICA	CRI>90
TENSIÓN	220-240 V
CORRIENTE	600 mA
VIDA UTIL	50.000 h

#### GENERAL DIMENSIONS

DIMENSIÓN	.02 (270x35mm)
ALTURA	h 80 mm
DIMENSIONES DE EMBALAJE	290 × 150 × 45 mm

\*Please might expect a max.15% figure reduction in finishes other than white