

nses
K51300.02.TR.BK-BK.30.ST.9.30.DA

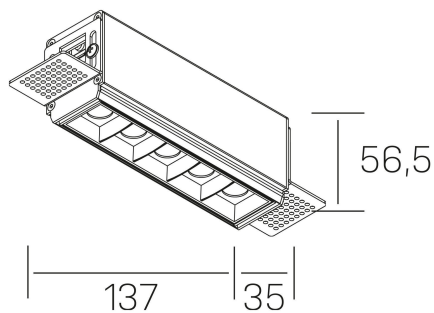

GENERAL DETAILS

INSTALACIÓN	Trimless
COLOR EXT-INT	Black-Black
DIRECCIÓN DE LA LUZ	Fixed
ÁNGULO DEL HAZ DE LUZ	30º
INT-EXT ESTANQUEIDAD	IP20
MATERIAL	Aluminum
RESISTENCIA MECÁNICA	IK 6
USO	Indoor
GARANTÍA	5 years

ELECTRICAL DETAILS

FUENTE DE LUZ	LED
POTENCIA	10W
TEMPERATURA DE COLOR	4000K
FLUJO LUMÍNICO	915 Lm
EFICIENCIA LUMÍNICA	76 Lm/W
DIMABLE	DALI
DRIVER	Remote
CLASE DE SEGURIDAD	II
ÍNDICE DE REPRODUCCIÓN CROMÁTICA	CRI>90
TENSIÓN	220-240 V
CORRIENTE	700 mA
VIDA UTIL	50.000 h

GENERAL DIMENSIONS

DIMENSIÓN	.02 (137x35mm)
AGUJERO DE CORTE	143x70 mm
ALTURA	h 56.5 mm
DIMENSIONES DE EMBALAJE	190 × 80 × 85 mm
PESO NETO	48

*Please might expect a max.15% figure reduction in finishes other than white