

**nses**  
K51300.01.RF.WH-BK.15.ST.9.27.PU

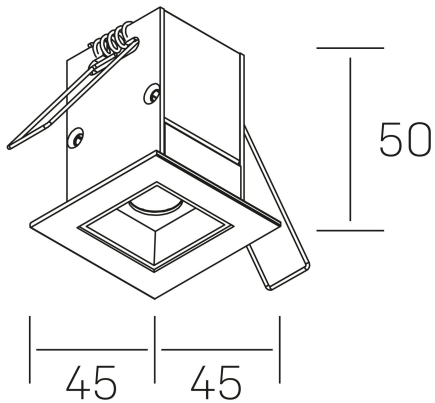

#### GENERAL DETAILS

INSTALACIÓN	recessed with frame
COLOR EXT-INT	Black-White
DIRECCIÓN DE LA LUZ	Fixed
ÁNGULO DEL HAZ DE LUZ	15º
INT-EXT ESTANQUEIDAD	IP20/23
MATERIAL	Aluminum
RESISTENCIA MECÁNICA	IK 6
USO	Indoor
GARANTÍA	5 years

#### ELECTRICAL DETAILS

FUENTE DE LUZ	LED
POTENCIA	2 W
TEMPERATURA DE COLOR	2700K
FLUJO LUMÍNICO	175 Lm
EFICIENCIA LUMÍNICA	58 Lm/W
DIMABLE	Push
DRIVER	Remote
CLASE DE SEGURIDAD	II
ÍNDICE DE REPRODUCCIÓN CROMÁTICA	CRI>90
TENSIÓN	220-240 V
CORRIENTE	700 mA
VIDA UTIL	50.000 h

#### GENERAL DIMENSIONS

DIMENSIÓN	.01 (45x45mm)
AGUJERO DE CORTE	37x37 mm
DIMENSIONES DE EMBALAJE	115 × 85 × 80 mm
PESO NETO	14

\*Please might expect a max. 15% figure reduction in finishes other than white