

GENERAL DETAILS

| | |
|-----------------------|---------------------|
| INSTALACIÓN | recessed with frame |
| COLOR EXT-INT | Black-Black |
| DIRECCIÓN DE LA LUZ | Fixed |
| ÁNGULO DEL HAZ DE LUZ | 28º |
| INT-EXT ESTANQUEIDAD | IP20/23 |
| MATERIAL | Aluminum |
| RESISTENCIA MECÁNICA | IK 6 |
| USO | Indoor |
| GARANTÍA | 5 years |

ELECTRICAL DETAILS

| | |
|----------------------------------|-----------|
| FUENTE DE LUZ | LED |
| POTENCIA | 16 W |
| TEMPERATURA DE COLOR | 3000K |
| FLUJO LUMÍNICO | 1261 Lm |
| EFICIENCIA LUMÍNICA | 79 Lm/W |
| DIMABLE | DALI |
| DRIVER | Remote |
| CLASE DE SEGURIDAD | II |
| ÍNDICE DE REPRODUCCIÓN CROMÁTICA | CRI>90 |
| TENSIÓN | 220-240 V |
| CORRIENTE | 500 mA |
| VIDA UTIL | 50.000 h |

GENERAL DIMENSIONS

| | |
|-------------------------|----------------|
| DIMENSIÓN | .10 (190x28mm) |
| AGUJERO DE CORTE | 186x24 mm |
| ALTURA | h 38 mm |
| DIMENSIONES DE EMBALAJE | N/A |

*Please might expect a max. 15% figure reduction in finishes other than white



lumo mini
K51302.10.RF.BK-BK.28.ST.9.30.DA

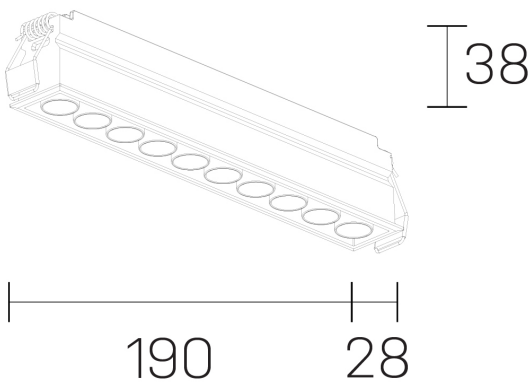

190 28

38