

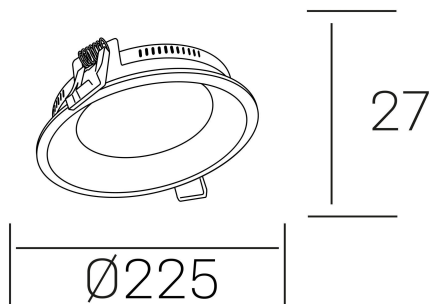

lim miranda
K53100.03.RF.WH-WH.OP.ST.8.30.DA



GENERAL DETAILS

INSTALACIÓN	recessed with frame
COLOR EXT-INT	White-White
DIFUSOR	Opal
DIRECCIÓN DE LA LUZ	Fixed
INT-EXT ESTANQUEIDAD	IP 44
MATERIAL	Aluminum
RESISTENCIA MECÁNICA	IK03
USO	Indoor
GARANTÍA	5 years

ELECTRICAL DETAILS

FUENTE DE LUZ	LED
POTENCIA	22 W
TEMPERATURA DE COLOR	3000K
FLUJO LUMÍNICO	1700 Lm
EFICIENCIA LUMÍNICA	73 Lm/W
DIMABLE	DALI
DRIVER	Remote
CLASE DE SEGURIDAD	II
ÍNDICE DE REPRODUCCIÓN CROMÁTICA	CRI >80
TENSIÓN	220-240 V
CORRIENTE	600 mA
VIDA UTIL	50.000 h

GENERAL DIMENSIONS

DIMENSIÓN	Ø 225 mm
AGUJERO DE CORTE	Ø 215 mm
ALTURA	h 27 mm
DIMENSIONES DE EMBALAJE	270 × 270 × 45 mm
PESO NETO	0.60

*Please might expect a max.15% figure reduction in finishes other than white