

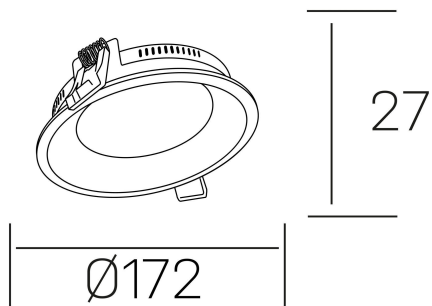

lim miranda
K53100.02.RF.WH-WH.OP.ST.8.40.DA



GENERAL DETAILS

INSTALACIÓN	recessed with frame
COLOR EXT-INT	White-White
DIFUSOR	Opal
DIRECCIÓN DE LA LUZ	Fixed
INT-EXT ESTANQUEIDAD	IP 44
MATERIAL	Aluminum
RESISTENCIA MECÁNICA	IK03
USO	Indoor
GARANTÍA	5 years

ELECTRICAL DETAILS

FUENTE DE LUZ	LED
POTENCIA	15 W
TEMPERATURA DE COLOR	4000K
FLUJO LUMÍNICO	1400 Lm
EFICIENCIA LUMÍNICA	90 Lm/W
DIMABLE	DALI
DRIVER	Remote
CLASE DE SEGURIDAD	II
ÍNDICE DE REPRODUCCIÓN CROMÁTICA	CRI >80
TENSIÓN	220-240 V
CORRIENTE	350 mA
VIDA UTIL	50.000 h

GENERAL DIMENSIONS

DIMENSIÓN	Ø 172 mm
AGUJERO DE CORTE	Ø 160 mm
ALTURA	h 27 mm
DIMENSIONES DE EMBALAJE	210 × 210 × 45 mm
PESO NETO	0.40

*Please might expect a max.15% figure reduction in finishes other than white